

Čelní stěna pro konec žlabu s odtokem DN 160 - obj. č. 11094

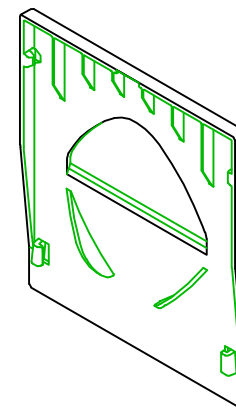
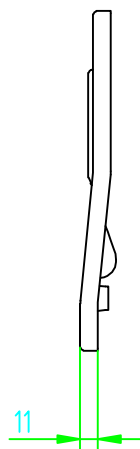
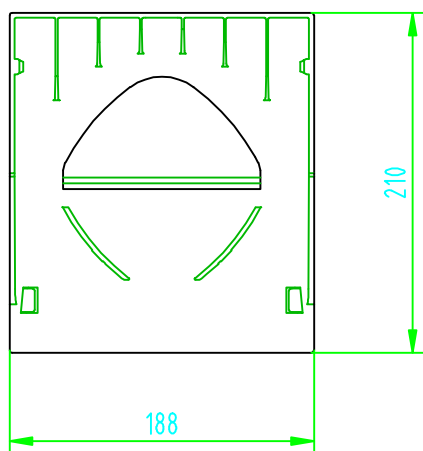

Kombinovaná čelní stěna pro začátek a konec žlabu - obj.č. 11093

ACO DRAIN X 150 C, X 150 S - čelní stěny